

LED BUS LIGHTING MR11

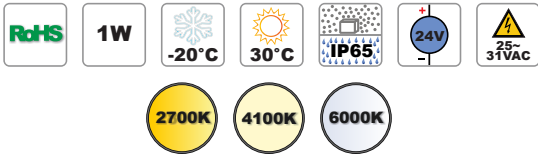

DESCRIPTION

LED MR11 lamp, for direct replacement to any type of application. Available in various voltage types and colors to best match your project requirements.

Specially produced for outdoor use, and high vibration environments. This MR11 is splash proof and tolerant of high vibration applications.

NOTES & PATENT INFORMATION

US Patent #7,307,391 8,115,411 8,791,650 9,179,513
 Canada Patent #2,651,224 2,555,065 2,831,641
 International Patents Pending
 For complete and up to date patent information see our website

DIMENSIONS

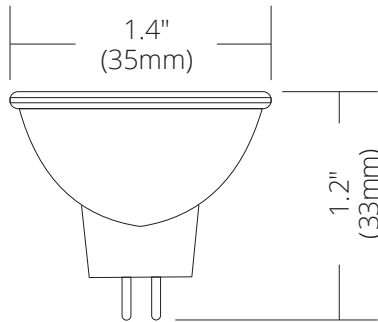

ELECTRICAL STATS

Operating Voltage	8-30VDC		28VAC (25-31VAC)			
Wattage	1W					
LED Color (CCT)	2700K	4100K	6000K	2700K	4100K	6000K
Light Output	85LM	85LM	85LM	85LM	85LM	85LM

ORDERING INFORMATION

